

Type **NAH90S-2-N IE3**

Cod.

Mounting position

IM	B3
IM	1001

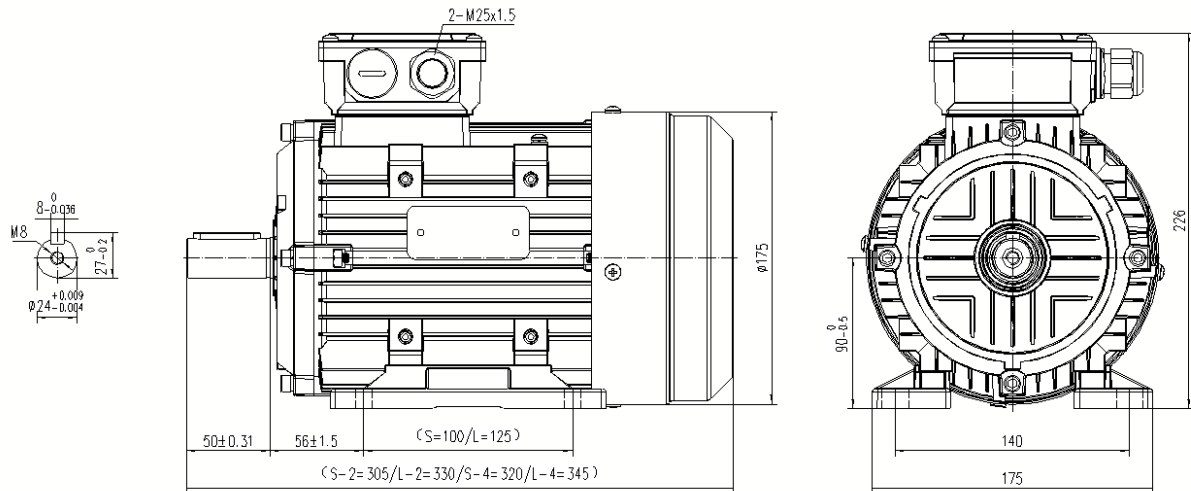

Electrical data			
Rated motor power	1.5		kW
Rated motor speed	2890		min ⁻¹ 50Hz
	3468		min ⁻¹ 60Hz
Rated motor frequency	50		Hz
Rated motor voltage(+/-10%)	230		VΔ/50Hz
	400		VY/50Hz
	280		VΔ/60Hz
	480		VY/60Hz
Rated motor torque	4.95		Nm (Mn)
Rated motor current	5.53	VΔ/50Hz	A (In)
	3.18	VY/50Hz	A (In)
Starting motor current	6.7		xIn
Starting motor torque	2.2		xMn
Breakdown motor torque	2.8		xMn
Starting			D.O.L.
Efficiency class	IE3		
Efficiency	50Hz	60Hz	
	84.3	85.5	100% load
	85.2	86.0	75% load
	85.0	84.9	50% load
Power factor cosφ	0.83	0.83	100% load

General data	
Frame size	90
Mounting	B3
Weight	14.7 kg
Casing material	Aluminum
Protection	IP 55
Insulation class/Temperature rise	F
Tropicalization	Yes
Vibration class	A
Duty	S1
Direction of rotation	Bidirectional
Method of cooling	IC 411
Cable entry	2-M25x1,5
Standards	IEC/DIN/ISO/VE/EN
Execute at Standard	IEC 60034-1
Feet removable	Yes
Paintwork	7030 C2 standard
Thermal protections	

Site conditions	
Ambient temperature	from -20°C to +40°C
Altitude above sea level	1000 m

Mechanical data					
Noise level	LpA	67	dB(A)	Bearing DE side	6205-2RZ ZV3
	LwA	69	dB(A)	Bearing NDE side	6205-2RZ ZV3
Moment of inertia	0.00186		kgm ²	Average bearing lifetime	40000 h
Bearings type			cgjf	Relubrication interval L1 DE bearing	life h
Lubricants for bearings	See installation and maintenance manual			Relubrication interval L1 NDE bearing	life h
				Compensation ring	DE SIDE