

Type **NAH90L-4-N IE3**

Cod.

Mounting position

IM	B34
IM	2101

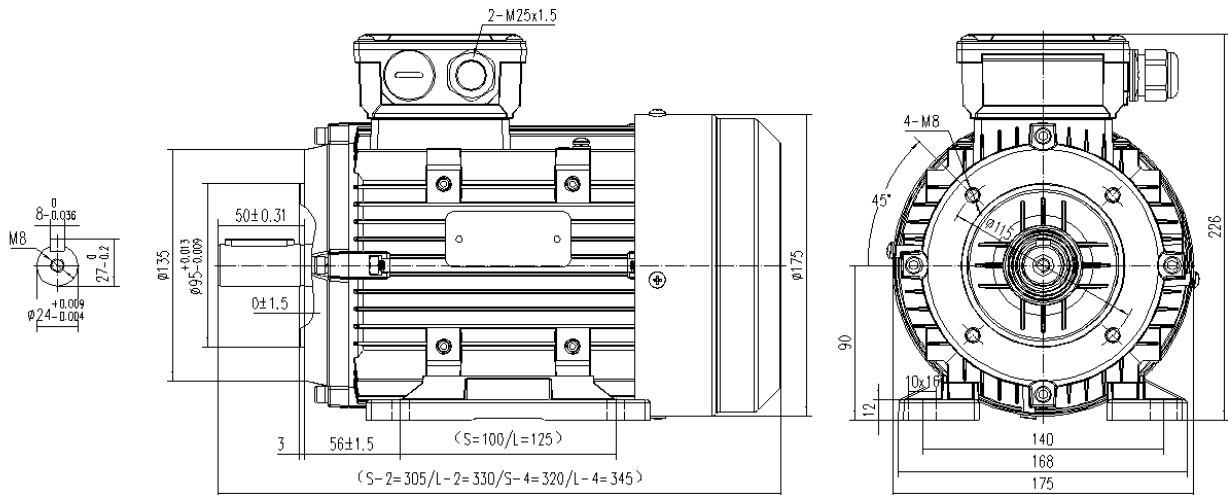

Electrical data			
Rated motor power	1.5		kW
Rated motor speed	1440		min ⁻¹ 50Hz
	1728		min ⁻¹ 60Hz
Rated motor frequency	50		Hz
Rated motor voltage(+/-10%)	230		VΔ/50Hz
	400		VY/50Hz
	280		VΔ/60Hz
	480		VY/60Hz
Rated motor torque	9.91		Nm (Mn)
Rated motor current	5.97	VΔ/50Hz	A (In)
	3.34	VY/50Hz	A (In)
Starting motor current	6.5		xIn
Starting motor torque	2.7		xMn
Breakdown motor torque	2.5		xMn
Starting			D.O.L.
Efficiency class	IE3		
Efficiency	50Hz	60Hz	
	85.4	86.6	100% load
	86.0	86.0	75% load
	85.2	85.2	50% load
Power factor cosφ	0.74	0.74	100% load

General data	
Frame size	90
Mounting	B34
Weight	19.2 kg
Casing material	Aluminum
Protection	IP 55
Insulation class/Temperature rise	F
Tropicalization	Yes
Vibration class	A
Duty	S1
Direction of rotation	Bidirectional
Method of cooling	IC 411
Cable entry	2-M25x1,5
Standards	IEC/DIN/ISO/DE/EN
Execute at Standard	IEC 60034-1
Feet removable	Yes
Paintwork	7030 C2 standard
Thermal protections	

Site conditions	
Ambient temperature	from -20°C to +40°C
Altitude above sea level	1000 m

Mechanical data					
Noise level	LpA	59	dB(A)	Bearing DE side	6205-2RZ ZV3
	LwA	64	dB(A)	Bearing NDE side	6205-2RZ ZV3
Moment of inertia	0.00426		kgm ²	Average bearing lifetime	40000 h
Bearings type			cgjf	Relubrication interval L1 DE bearing	life h
Lubricants for bearings	See installation and maintenance manual			Relubrication interval L1 NDE bearing	life h
				Compensation ring	DE SIDE