

Type **NAH132S1-2-N IE3**

Cod.

Mounting position

IM	B3
IM	1001

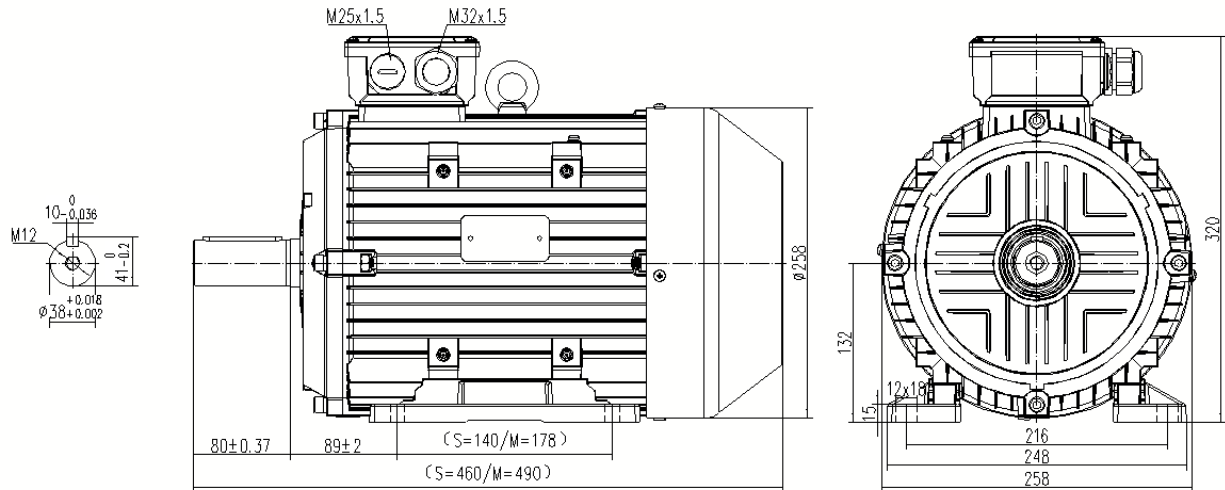

Electrical data			
Rated motor power	5.5		kW
Rated motor speed	2930		min ⁻¹ 50Hz
	3516		min ⁻¹ 60Hz
Rated motor frequency	50		Hz
Rated motor voltage(+/-10%)	400		VΔ/50Hz
	690		VY/50Hz
	480		VΔ/60Hz
	830		VY/60Hz
Rated motor torque	17.9		Nm (Mn)
Rated motor current	10.2	VΔ/50Hz	A (In)
	5.92	VY/50Hz	A (In)
Starting motor current	8.6		xIn
Starting motor torque	2.4		xMn
Breakdown motor torque	4.1		xMn
Starting			D.O.L.
Efficiency class	IE3		
Efficiency	50Hz	60Hz	
	89.2	89.5	100% load
	89.9	90.2	75% load
	90.4	90.4	50% load
Power factor cosφ	0.88	0.88	100% load

General data	
Frame size	132
Mounting	B3
Weight	41.5 kg
Casing material	Aluminum
Protection	IP 55
Insulation class/Temperature rise	F
Tropicalization	Yes
Vibration class	A
Duty	S1
Direction of rotation	Bidirectional
Method of cooling	IC 411
Cable entry	1-M25x1.5, 1-M32x1.5
Standards	IEC/DIN/ISO/DE/EN
Execute at Standard	IEC 60034-1
Feet removable	Yes
Paintwork	7030 C2 standard
Thermal protections	

Site conditions	
Ambient temperature	from -20°C to +40°C
Altitude above sea level	1000 m

Mechanical data			
Noise level	LpA	79	dB(A)
	LwA	81	dB(A)
Moment of inertia	0.0128		kgm ²
Bearings type			cgjf
Lubricants for bearings	See installation and maintenance manual		
Bearing DE side	6308-2RZ ZV3		
Bearing NDE side	6308-2RZ ZV3		
Average bearing lifetime	40000		h
Relubrication interval L1 DE bearing	life		h
Relubrication interval L1 NDE bearing	life		h
Compensation ring	DE SIDE		standard