

Type **NAH100L-2-N IE3**

Cod.

Mounting position

IM	B34
IM	2101

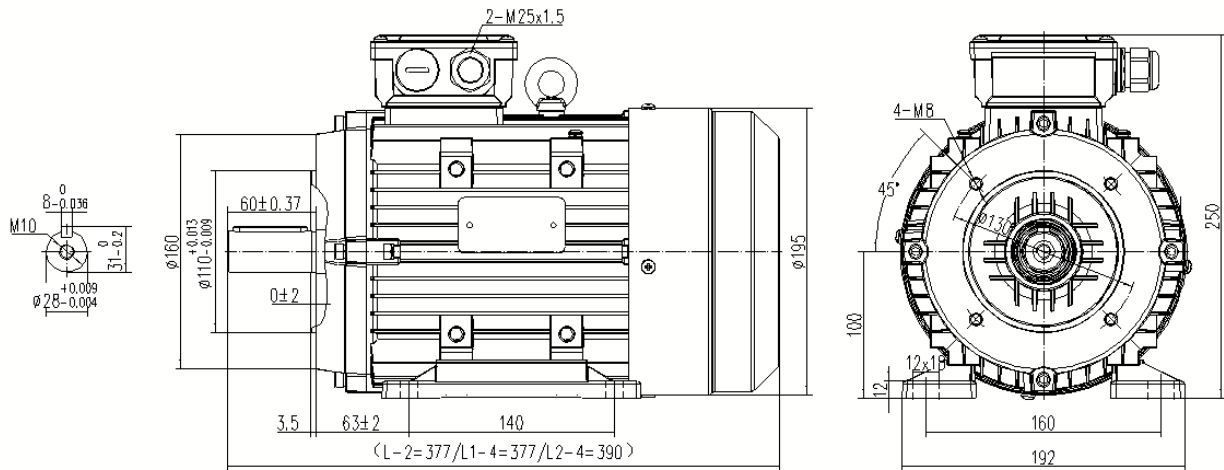

Electrical data			
Rated motor power	3.0		kW
Rated motor speed	2890		min ⁻¹ 50Hz
	3468		min ⁻¹ 60Hz
Rated motor frequency	50		Hz
Rated motor voltage(+/-10%)	230		VΔ/50Hz
	400		VY/50Hz
	280		VΔ/60Hz
	480		VY/60Hz
Rated motor torque	9.9		Nm (Mn)
Rated motor current	9.83	VΔ/50Hz	A (In)
	5.65	VY/50Hz	A (In)
Starting motor current	8.5		xIn
Starting motor torque	3.0		xMn
Breakdown motor torque	3.5		xMn
Starting			D.O.L.
Efficiency class	IE3		
Efficiency	50Hz	60Hz	
	87.3	88.2	100% load
	87.6	88.5	75% load
	87.8	88.0	50% load
Power factor cosφ	0.88	0.88	100% load

General data		
Frame size	100	
Mounting	B34	
Weight	23	kg
Casing material	Aluminum	
Protection	IP	55
Insulation class/Temperature rise	F	
Tropicalization	Yes	
Vibration class	A	
Duty	S1	
Direction of rotation	Bidirectional	
Method of cooling	IC	411
Cable entry	2-M25x1.5	
Standards	IEC/DIN/ISO/DE/EN	
Execute at Standard	IEC 60034-1	
Feet removable	Yes	
Paintwork	7030	C2 standard
Thermal protections		

Site conditions	
Ambient temperature	from -20°C to +40°C
Altitude above sea level	1000 m

Mechanical data					
Noise level	LpA	74	dB(A)	Bearing DE side	6206-2RZ ZV3
	LwA	76	dB(A)	Bearing NDE side	6206-2RZ ZV3
Moment of inertia	0.00403		kgm ²	Average bearing lifetime	40000 h
Bearings type			cgjf	Relubrication interval L1 DE bearing	life h
Lubricants for bearings	See installation and maintenance manual			Relubrication interval L1 NDE bearing	life h
				Compensation ring	DE SIDE